



MSW2T-2050-194/MSW2T-2051-194

SP2T Surface Mount High Power PIN Diode Switch

Features:

- Wide Operating Frequency Band: 50 MHz to 4 GHz, in two bands
- Surface Mount SP2T Switch – 5mm x 8mm x 2.5mm
- Industry Leading Average Power Handling – 160W CW
- High Voltage rating greater than 500V support Higher RF Peak Power - >630W
- Low Insertion Loss (< 0.25 dB) and High IP3 (>65 dBm)
- Operates from Positive Only Voltages: +5V and +28V to +125V
- High Linearity
- RoHS Compliant

Description:

The MSW2T-205X-194 series SP2T surface mount High Power PIN Diode switches are available in two operating frequency bands: MSW2T-2050-194 operates from 50 MHz to 1 GHz and MSW2T-2051-194 operates from 400 MHz to 4 GHz. The MSW2T-205X-194 series of high power switches leverage high reliability hybrid manufacturing processes which yield proven superior performance to both MMIC and Glass Carrier based technologies. The hybrid design approach permits precise PIN Diode selection to optimize RF performance while maintaining competitive cost targets. The small form factor (8mm x 5mm x 2.5mm) offers world class power handling, low insertion loss, and superior intermodulation performance exceeding all competitive technologies.

The MSW205X-194 family of asymmetrical switches are tailored to minimize Transmit to Antenna loss while maximizing Transmit to Receive isolation and to enable maximum flexibility as the designer can assign either port as Transmit Port and the other the Receive Port. The extremely low thermal resistance of the hybrid assembly permits reliably handling up to 50 dBm CW power and up to 58 dBm peak RF incident power while operating at the $T_{(amb) MAX} = +85^{\circ}C$.

Typical Applications:

- Radar T/R Modules
- High Power Transmit/Receive Switching
- Switch Bank Filters
- Mil-Com Radios

The MSW2T-205X-194 series of High Power SP2T switches are intended for use in high power, high reliability, mission critical applications across the HF to S Band frequency ranges. The manufacturing process has been proven through decades of extensive use in high reliability applications.

ESD and Moisture Sensitivity Level Rating:

The MSW2T-205X-194 family of SP2T switches are fully RoHS compliant. The MSW2T-205X-194 carries an ESD ratings of Class 1C, Human Body Model (HBM) and a moisture sensitivity rating of MSL 1.

MSW2T-205X-194 Schematic

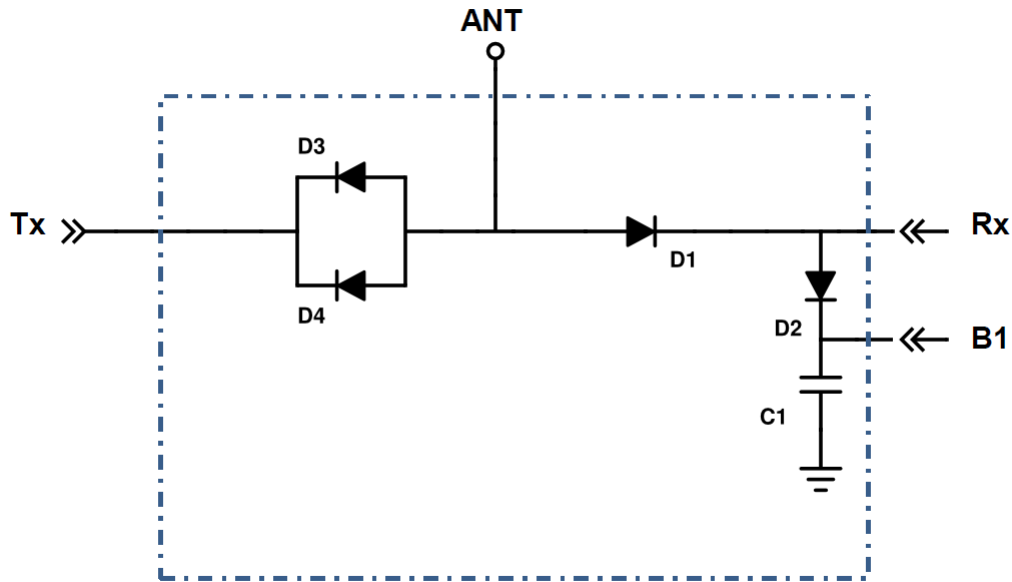

Control Truth Table for MSW2T-205X-194

+V_{cc1} = 5V and +V_{cc2} = 28V (unless otherwise noted)

	State 1	State 2
Condition	Tx-Ant: Low Insertion Loss Tx-Rx: Isolation	Ant-Rx: Low Insertion Loss Rx-Tx: Isolation
ANT	+5V @ +100mA	+5V @ +100mA
TX	0V @ +100mA	+28V @ 0 mA
RX	+28V @ 25mA	0V @ +100mA
B1	0V @ +25mA	+28V @ 0mA

Notes:

- 1) $28\text{ V} \leq V_{\text{HIGH}} \leq 125\text{ V}$
- 2) PIN diode min reverse DC voltage (V_{HIGH}) to maintain high resistance state in the OFF PIN diode is determined by RF frequency. Incident power, duty cycle, characteristic impedance and VSWR as well as by characteristics of the diode. The recommended min reverse bias voltage (V_{HIGH}) values are provided in the Min Reverse Bias Voltage Table of this data sheet.

Control Conditions Table

	State 1	State 2
Condition	Tx-Ant: Low Insertion Loss Tx-Rx: Isolation	Ant-Rx: Low Insertion Loss Rx-Tx: Isolation
ANT	+5V @ +100mA	+5V @ +100mA
TX	0V @ +100mA	+28V @ 0 mA
RX	+28V @ 25mA	0V @ +100mA
DC	0V @ +25mA	+28V @ 0mA

MSW2T-2050-194 Electrical Specifications @ $Z_o = 50\Omega$; $T_a = +25^\circ\text{C}$

Parameter	Symbol	Test Condition	Min Value	Typ Value	Max Value	Units
Frequency	F		50		1,000	MHz
Tx-Ant Insertion Loss	IL (Tx)	Condition 1		0.15	0.25	dB
Ant – Rx Insertion Loss	IL (Rx)	Condition 2		0.25	0.35	dB
Tx-Ant Return Loss	RL (Tx)	Condition 1	18	20		
Ant – Rx Return Loss	RL (Rx)	Condition 2	20	22		dB
Tx – Rx Isolation	ISO (Tx)	Condition 1	47	50		
Rx – Tx Isolation	ISO (Rx)	Condition 2	23	26		dB
Tx CW Incident Power (Note 2)	Pinc(CW)	Condition 1, Source & Load VSWR = 1.5:1			52	
Rx CW Incident Power (Note 2)	Pinc(CW)	Condition 2, Source & Load VSWR = 1.5:1			43	dBm
Peak Incident Power (Note 2)	Pinc(Pk)	Source & Load VSWR = 1.5:1 Pulse width = 10 us, Duty Cycle = 1%			58	dB
Switching Time	t_{sw}	Condition 1, 10% to 90% RF Voltage, TTL rep rate = 100 kHz		1	1.5	usec
Input 3 rd Order Intercept Point	IIP3	$F_1=500\text{ MHz}$, $F_2=510\text{ MHz}$, $P_1=P_2=40\text{ dBm}$	60	65		dBm

MSW2T-2050-194 Electrical Specifications @ $Z_0 = 50\Omega$; $T_a = +25^\circ\text{C}$

Parameter	Symbol	Test Condition	Min Value	Typ Value	Max Value	Units
Frequency	F		400		4,000	MHz
Tx-Ant Insertion Loss	IL (Tx)	Condition 1		0.3	0.4	dB
Ant – Rx Insertion Loss	IL (Rx)	Condition 2		0.8	0.9	dB
Tx-Ant Return Loss	RL (Tx)	Condition 1	15	17		
Ant – Rx Return Loss	RL (Rx)	Condition 2	15	17		dB
Tx – Rx Isolation	ISO (Tx)	Condition 1	32	34		
Rx – Tx Isolation	ISO (Rx)	Condition 2	11	13		dB
Tx CW Incident Power (Note 2)	Pinc(CW)	Condition 1, Source & Load VSWR = 1.5:1			52	
Rx CW Incident Power (Note 2)	Pinc(CW)	Condition 2, Source & Load VSWR = 1.5:1			43	dBm
Peak Incident Power (Note 2)	Pinc(Pk)	Source & Load VSWR = 1.5:1 Pulse width = 10 us, Duty Cycle = 1%			58	dB
Switching Time	t_{sw}	Condition 1, 10% to 90% RF Voltage, TTL rep rate = 100 kHz		1	1.5	usec
Input 3 rd Order Intercept Point	IIP3	$F_1=500\text{ MHz}$, $F_2=510\text{ MHz}$, $P_1=P_2=40\text{ dBm}$	60	65		dBm

Notes:

- Switching speed from 50% TTL control signal to 10%/90% RF Voltage is a function of the PIN diode driver performance in conjunction with the PIN diode characteristics. An RC "current spiking network" may be used on the driver output to provide a transient current to rapidly removed stored charge from the I region of the PIN diode. Typical component values are: R = 50 to 220 Ω and C = 470 to 1,000pF.
- The PIN diode DC reverse voltage used to maintain a high resistance state during the OFF state is determined by the RF frequency, incident power, and VSWR as well as the characteristics of the PIN diode. The minimum reverse bias voltage values are provided in this data sheet. The input signal level applied to test small signal performance is 0 dBm.

RF Bias Network Recommended Component Values

Part Number	Operating Frequency (MHz)	DC Blocking Capacitors	Inductors	RF Bypass Capacitors
MSW2T-2050-194	50 – 1,000	0.1 μF	4.7 μH	0.1 μF
MSW2T-2051-194	400 – 4,000	27 pF	82 nH	270 pF

MSW2T-205X-194 Minimum Reverse Bias Voltage Table

Part Number	Frequency of Operation (MHz)					
	20 - 100	100 - 200	200 - 400	400 – 1,000	1,000 – 4,000	>4,000
MSW2T-2050-194	125V	125V	85V	55V	28V	N/A
MSW2T-2051-194	N/A	N/A	125V	85V	55V	28V

Note: N/A denotes an operating frequency outside the normal switch operating frequency range.

MSW2T-205X-194 Absolute Maximum Ratings @ $T_A = +25^\circ\text{C}$ (unless otherwise denoted)

Parameters	Conditions	Absolute Maximum Value
Forward Current – Ant, Tx or Rx Port		250mA
Forward Current – DC Port		150mA
Reverse Voltage – Tx or Rx Port		125V
Reverse Voltage – DC Port		125V
Forward Diode Voltage	$I_F = 250\text{mA}$	1.2V-
Operating Temperature		-55°C to $+125^\circ\text{C}$
Storage Temperature		-65°C to $+150^\circ\text{C}$
Junction Temperature		$+175^\circ\text{C}$
Assembly Temperature		260°C for 10 sec
CW Incident Power Handling – Tx or Antenna Port (Note 1)	Source & Load VSWR = 1.5:1, TCASE = 85°C , cold switching	52 dBm
CW Incident Power Handling – Rx or Antenna Port (Note 1)	Source & Load VSWR = 1.5:1, T _{CASE} = 85°C , cold switching	43 dBm
Peak Incident Power Handling – Tx or Antenna Port (Note 1)	Source & Load VSWR = 1.5:1, TCASE = 85°C , cold switching, Pulse Width = 10 us, Duty Cycle = 1%	58 dBm
Total Dissipated RF & DC Power (Note 1)	TCASE = 85°C , cold switching	8W

Notes:

- 1) Backside RF, DC and Thermal Ground area of device must be completely solder attached to RF circuit board vias for proper electrical and thermal circuit grounding.

MSW2T-2050-194 Small Signal Parametric Performance:

MSW2T-2050-194: TX and Rx Insertion Loss vs Frequency

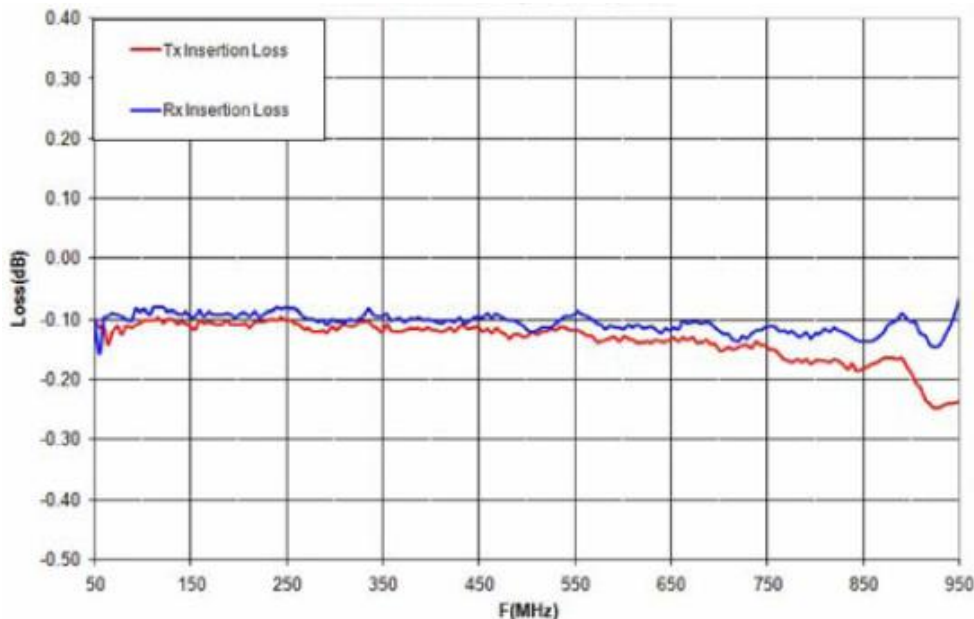

MSW2T-2050-194: Tx and Rx Return Loss vs Frequency

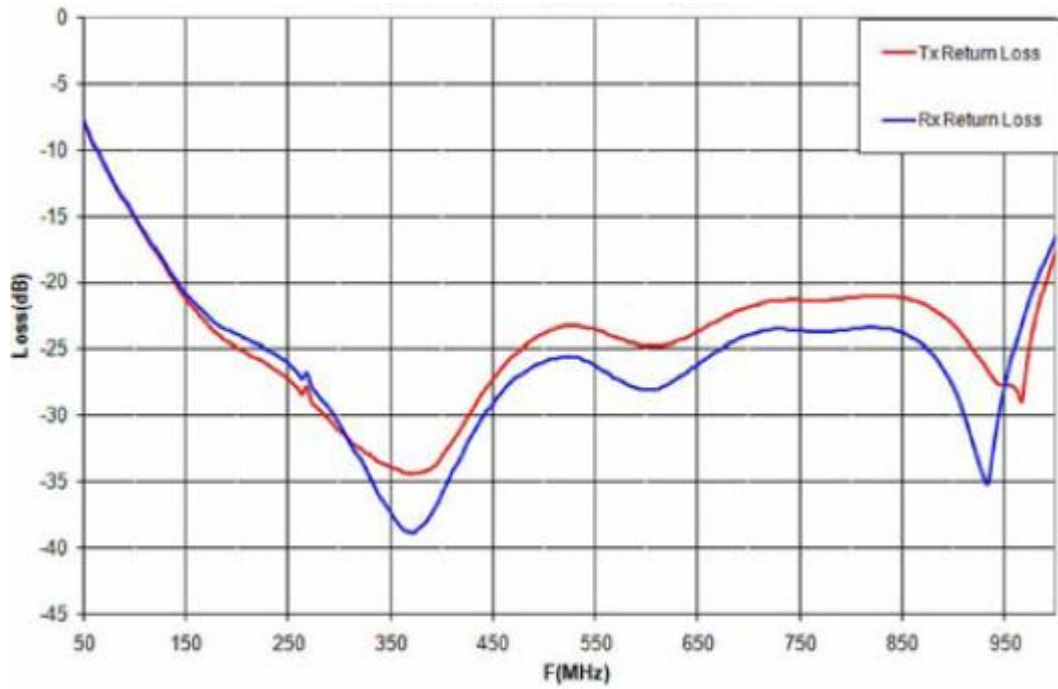

MSW2T-2050-194: Tx and Rx Isolation vs Frequency

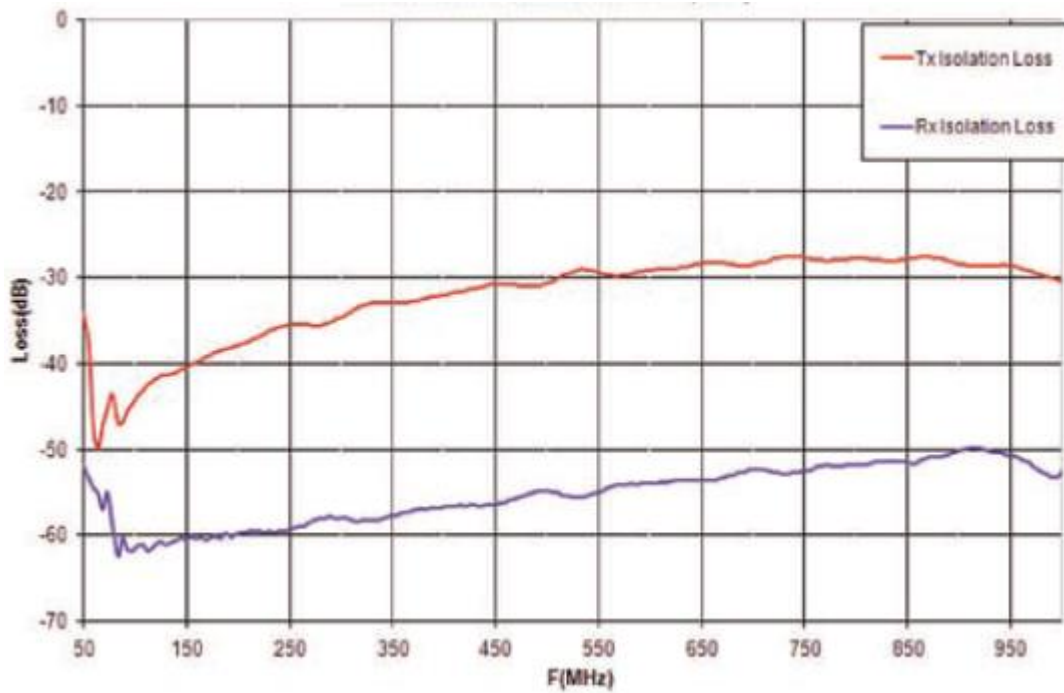

MSW2T-2051-194: Small Signal Parametric Performance:

MSW2T-2051-194: Tx-Ant and Ant-Rx Insertion Loss vs Frequency

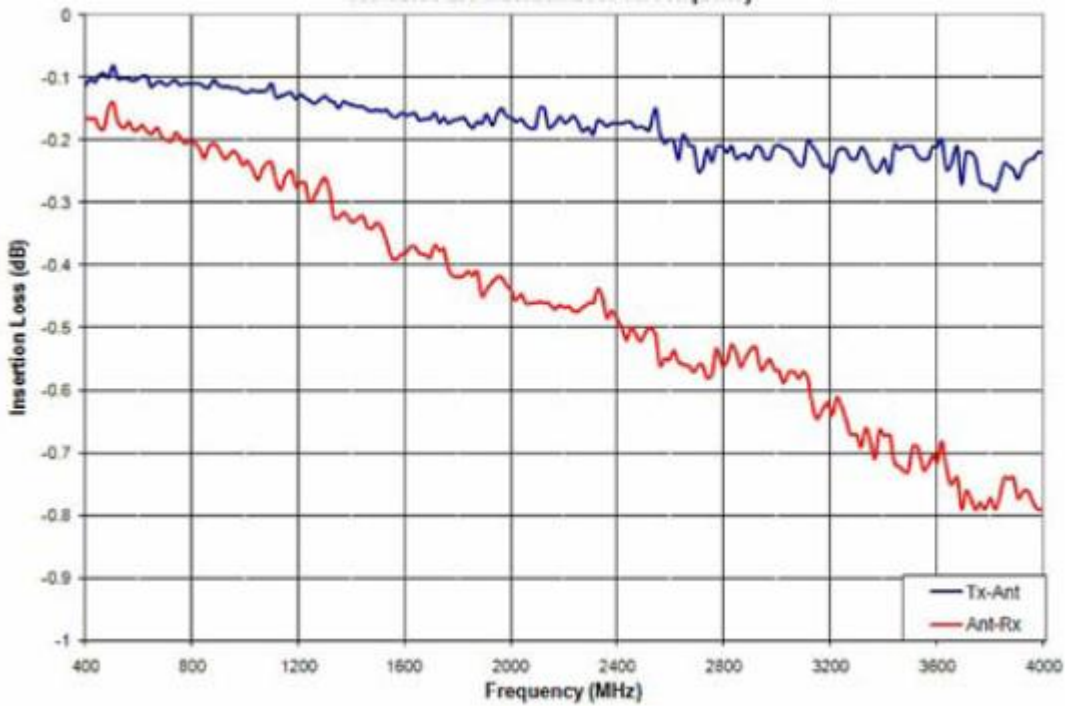

MSW2T-2051-194: Tx-Ant and Ant-Rx Return Loss vs Frequency

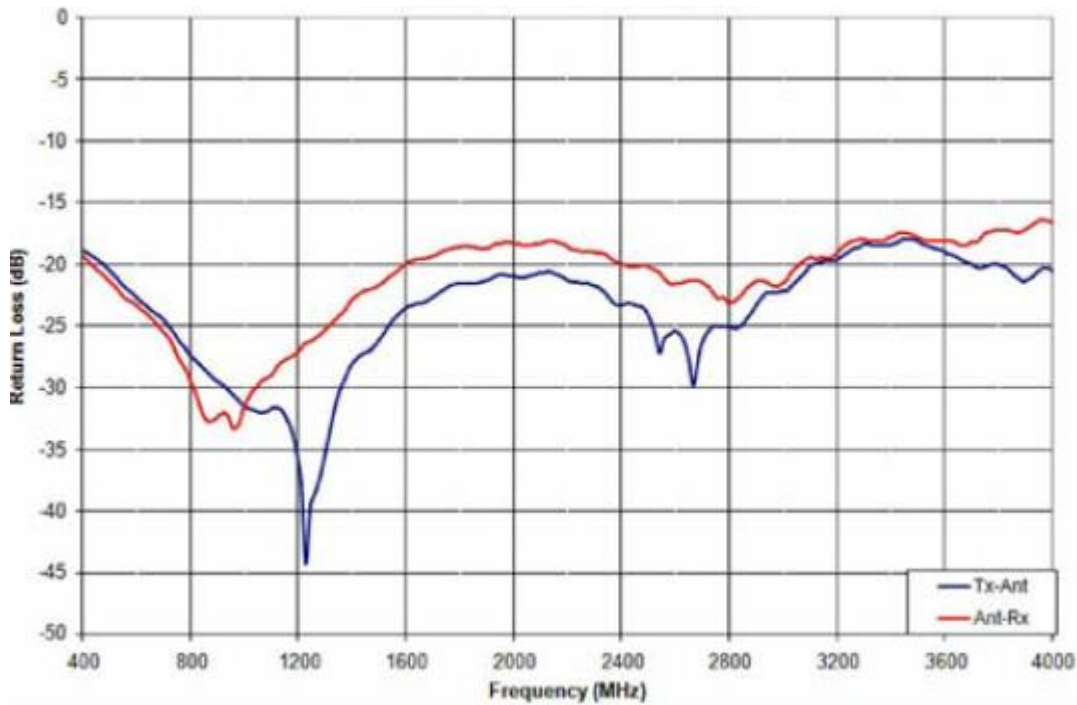

MSW2T-2051-194: Tx-Ant and Ant-Rx Isolation vs Frequency

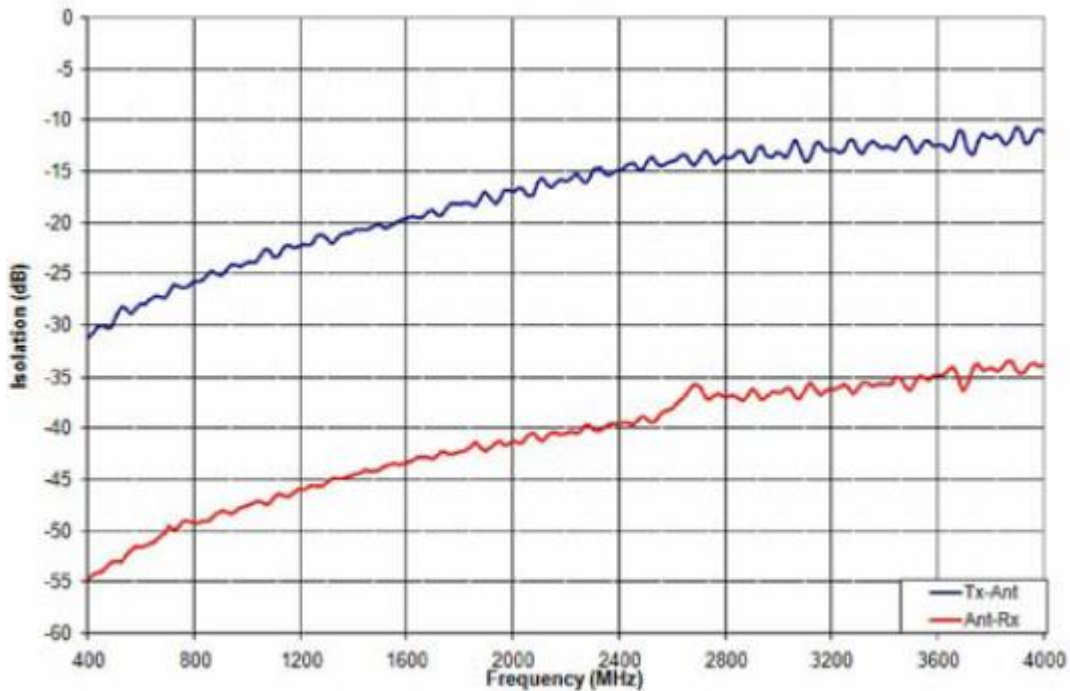

Assembly Instructions

The MSW2T-205X-194 family of High Power Switches are available in either tube or Tape & Reel format. The MSW2T-205X-194 may be attached to the printed circuit card using solder reflow procedures using either RoHS or Sn63/ Pb37 type solders per the Table and Temperature Profile Graph shown below:

Profile Parameter	Sn-Pb Assembly Technique	RoHS Assembly Technique
Average ramp-up rate (T_L to T_P)	3°C/sec (max)	3°C/sec (max)
Preheat		
Temp Min (T_{smin})	100°C	100°C
Temp Max (T_{smax})	150°C	200°C
Time (min to max) (t_s)	60 – 120 sec	60 – 180 sec
T_{smax} to T_L		
Ramp up Rate		3°C/sec (max)
Peak Temp (T_P)	225°C +0°C / -5°C	260°C +0°C / -5°C
Time within 5°C of Actual Peak Temp (T_P)	10 to 30 sec	20 to 40 sec
Time Maintained Above:		
Temp (T_L)	183°C	217°C
Time (t_L)	60 to 150 sec	60 to 150 sec
Ramp Down Rate	6°C/sec (max)	6°C/sec (max)
Time 25°C to T_P	6 minutes (max)	8 minutes (max)

Solder Re-Flow Time-Temperature Profile

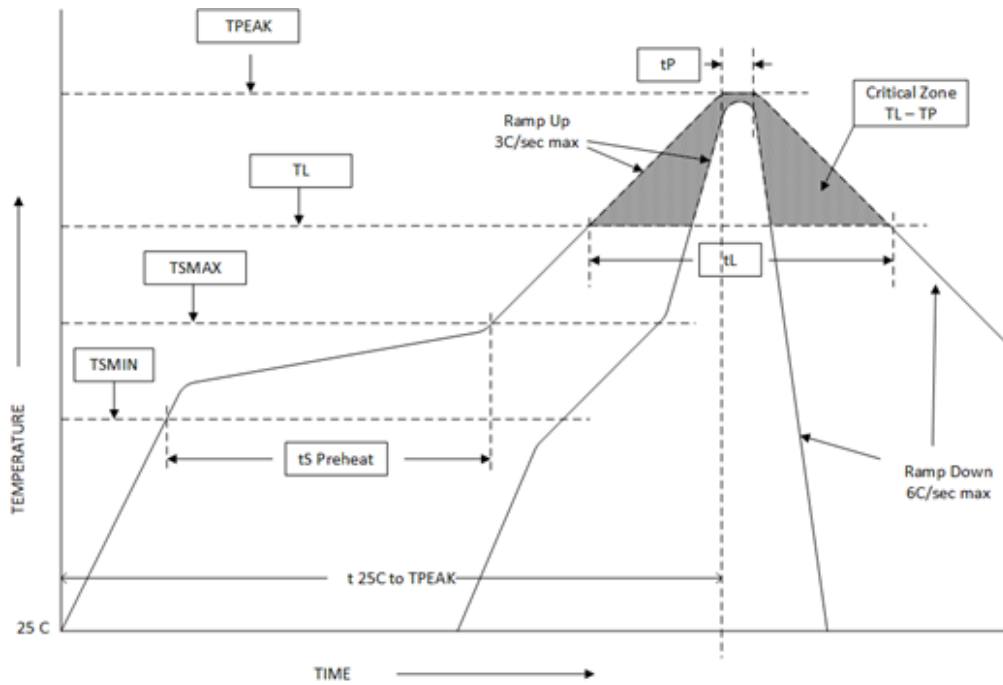

MSW2T-205X-194 SP2T Package Outline Drawing

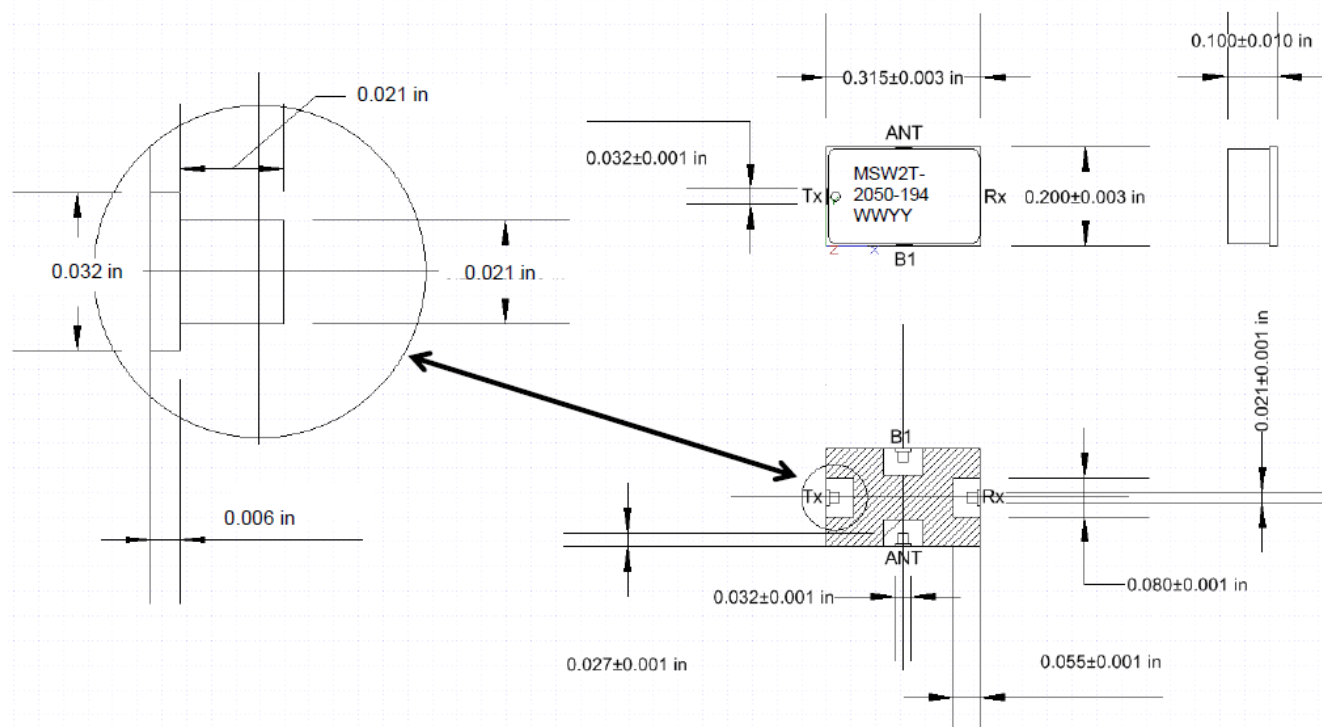

Note: Metalized area on backside is the RF, DC and Thermal ground. In user's end application this surface temperature must be managed to meet the power handling requirements.

Thermal Design Considerations:

The design of the MSW2T-205X-194 family of High Power Switches permits the maximum efficiency in thermal management of the PIN Diodes while maintaining extremely high reliability. Optimum switch performance and reliability of the switch can be achieved by the maintaining the base ground surface temperature of less than 85°C.

Recommended RF Circuit Solder Footprint for the MSW2T-205X-194

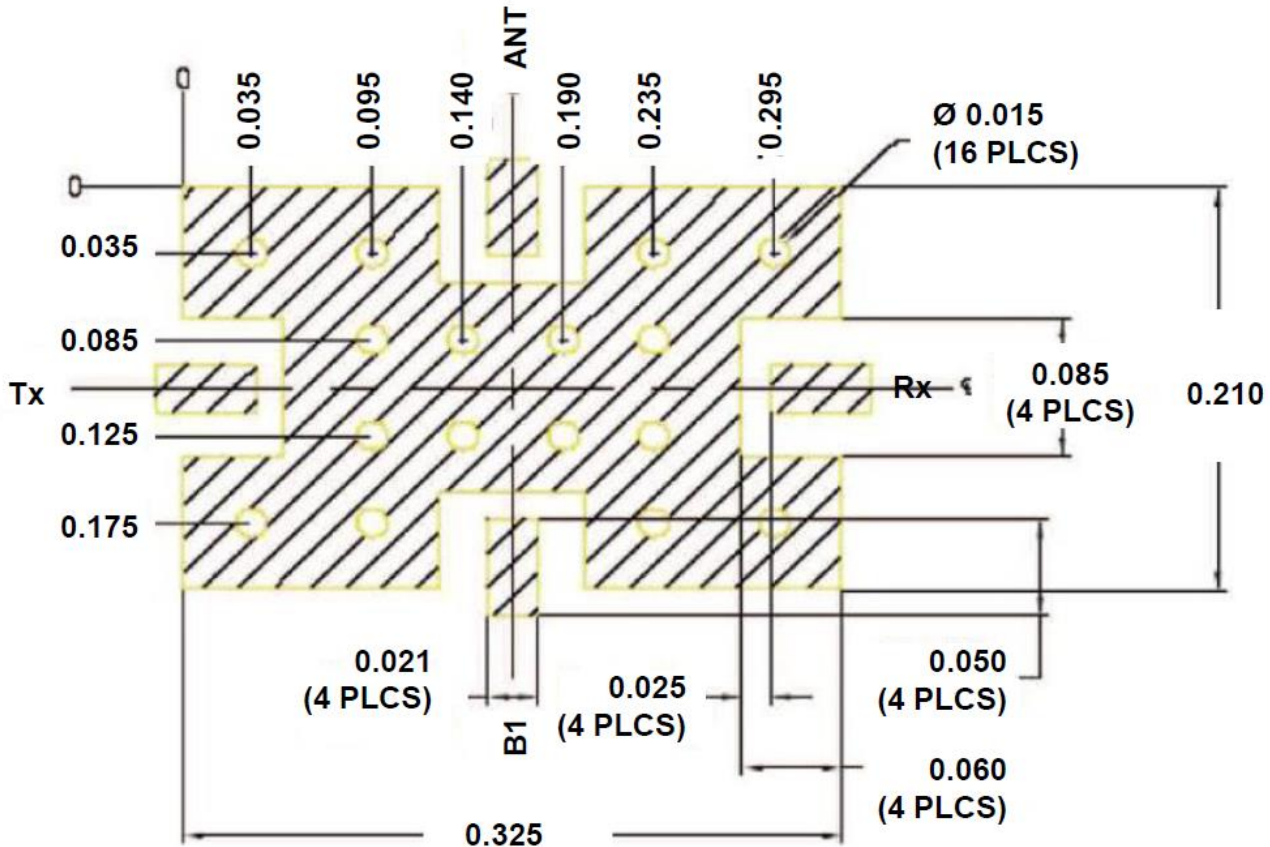

Notes:

- 1) All dimensions in inches.
- 2) Recommended RF Circuit Rogers: R04350B, 10 mils Thick.

Part Number Ordering Details:

Part Number	Packaging
MSW2T-2050-194	Tube
MSW2T-2050-194TR	Tape & Reel (250 pcs)
MSW2T-2051-194	Tube
MSW2T-2051-194TR	Tape & Reel (250 pcs)